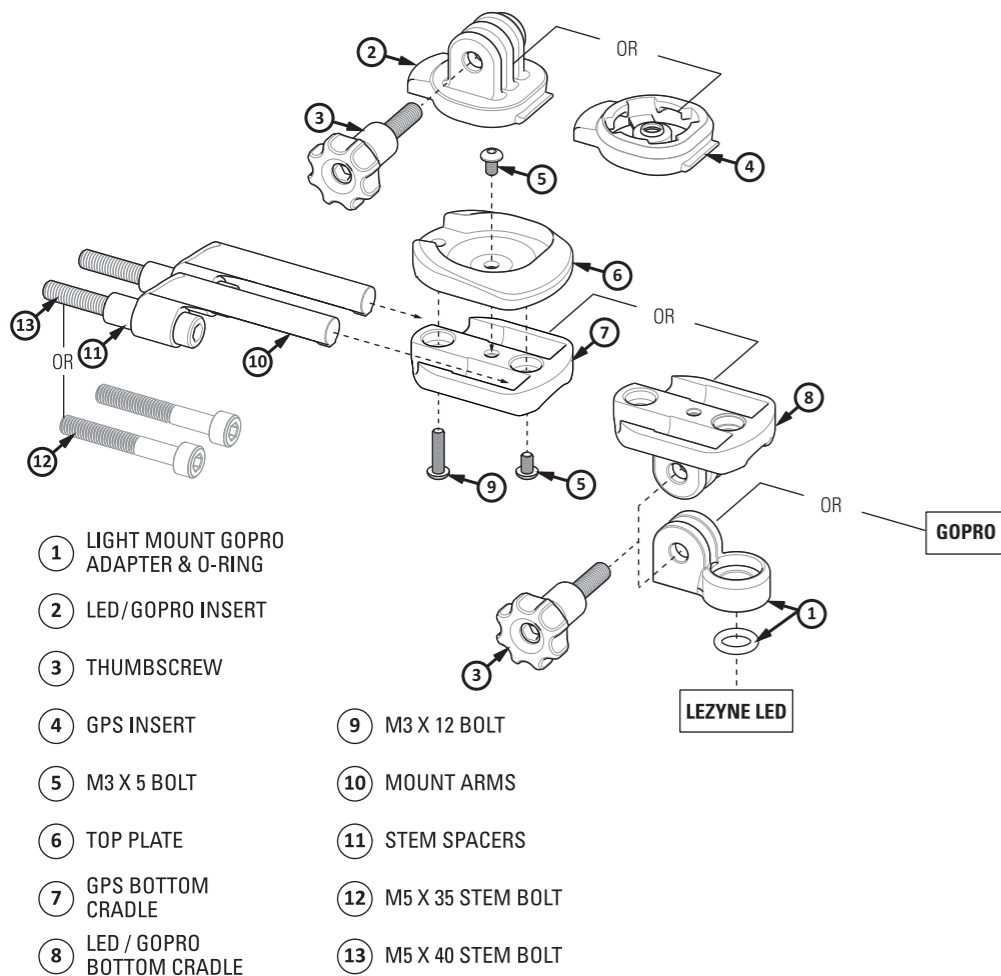

Components:

- ① LIGHT MOUNT GOPRO ADAPTER & O-RING
- ② LED/GOPRO INSERT
- ③ THUMBSCREW
- ④ GPS INSERT
- ⑤ M3 X 5 BOLT
- ⑥ TOP PLATE
- ⑦ GPS BOTTOM CRADLE
- ⑧ LED / GOPRO BOTTOM CRADLE
- ⑨ M3 X 12 BOLT
- ⑩ MOUNT ARMS
- ⑪ STEM SPACERS
- ⑫ M5 X 35 STEM BOLT
- ⑬ M5 X 40 STEM BOLT

Step 1: Install M5X35mm or M5X40mm bolts into STEM SPACERS and MOUNT ARMS.

Components: ⑩ + ⑪ + ⑫ OR ⑬ *Note: Use only DIRECT X-LOCK HARDWARE for installation.*

1. Loosen all factory stem face plate bolts. Remove desired bolts that will be replaced by DIRECT X-LOCK STEM BOLTS.
2. Place factory stem bolts next to assembled DIRECT X-LOCK MOUNT. Compare exposed DIRECT X-LOCK BOLT length to factory bolts. DIRECT X-LOCK MOUNT BOLT length needs to match factory bolt length within +/- 1mm. Compare both 35mm and 40 mm bolts to factory hardware. If assembled bolt, arm, and spacer length does not match factory bolt length +/- 1mm, contact Lezyne.

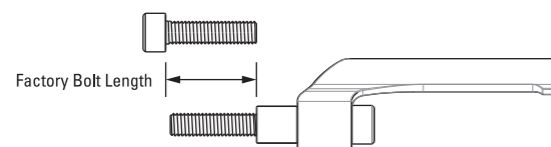

4. Install the DIRECT X-LOCK STEM BOLTS with 9mm STEM SPACERS and MOUNT ARMS into chosen stem bolt holes.

See Position Chart to choose stem bolt holes.

5. Torque ALL BOLTS to stem manufacturer's torque specs and stem manufacturer's tightening pattern.
6. Make sure MOUNT ARMS are level with each other and fit within bottom cradle.

Note: Final position cannot be adjusted after bolts are fully tightened.

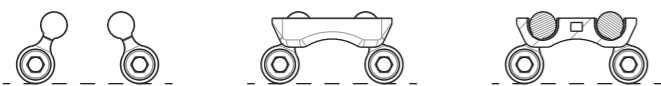
**Step 2: Place BOTTOM cradle and TOP plate on arms and install top M3X5 bolt.**

Components: ⑤ + ⑥ + ⑦ OR ⑧ + ② OR ④ + ⑨

1. Torque TOP M3X5 bolt to 6kgf-cm max.
2. Install INSERT into TOP PLATE with M3X12 bolt, torque to 6kgf-cm max.
3. Install BOTTOM M3X5 BOLT, torque to 6kgf-cm max.

See Combinations to choose bottom cradle and insert.

Position - Visit lezyne.com for more compatibility information.

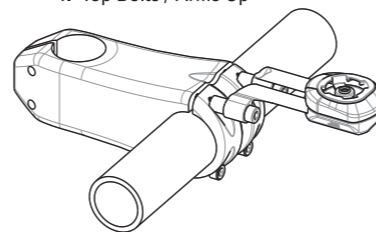
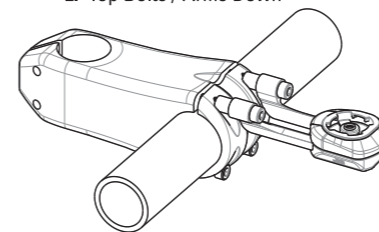
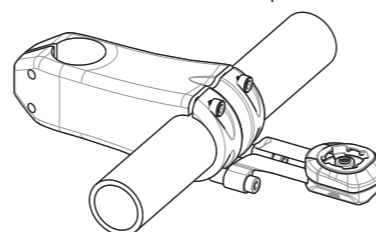
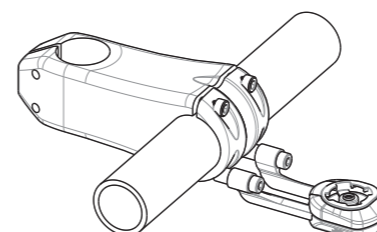
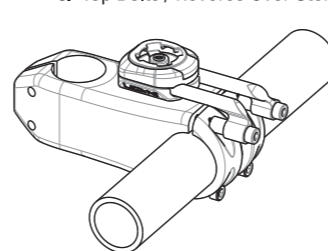
1. Top Bolts / Arms Up**2. Top Bolts / Arms Down****3. Bottom Bolts / Arms Up****4. Bottom Bolts / Arms Down****5. Top Bolts / Reverse Over Stem****Combinations**

④ + ⑥ + ⑦

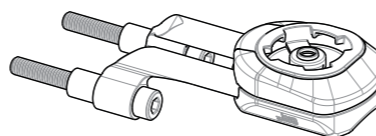

① + ③ + ④ + ⑥ + ⑧

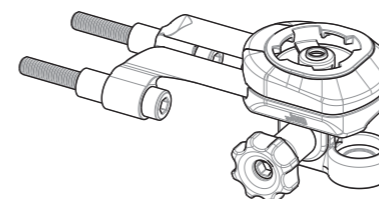

② + ⑥ + ⑦

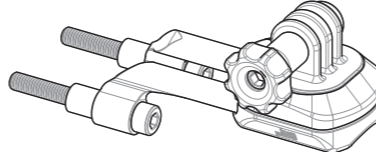

① + ② + ③ + ⑥ + ⑧

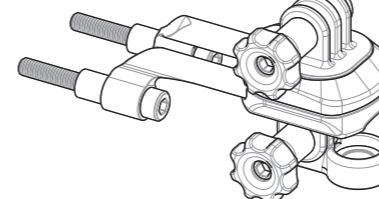
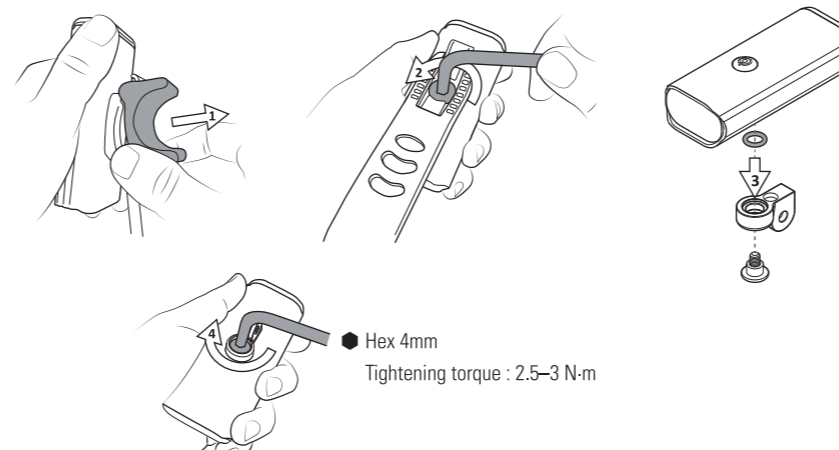
**① Lezyne LED GOPRO Adapter****Computer Mounting**

Push & turn into mount

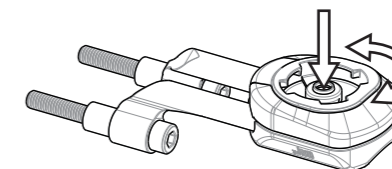
**Warnings**

Follow all installation instructions for the Lezyne DIRECT X-LOCK. This is critical for the successful and safe use on your bicycle. Read all instructions and follow all warnings before installing this product. Any questions should be forwarded to Lezyne Customer Service Department. Failure to follow installation instructions may result in product failure and void the warranty.

- Do not exceed DIRECT X-LOCK BOLT torque.
 - 6kgf-cm for M3 DIRECT X-LOCK BOLTS
 - For M5 Stem bolts follow stem manufacturers specifications.
- Ensure DIRECT X-LOCK clears all cables of bicycle.
- Check for interference between control cables and mounted items.
- Use only included DIRECT X-LOCK HARDWARE.
- Check torque of all stem bolts and DIRECT X-LOCK HARDWARE before every ride.
- Ensure GPS/Light/GoPro are secure before riding.
- Do not exceed 310g load on top insert or bottom cradle. Do not exceed 495g total load (top insert load + bottom cradle load).
- After a crash replace DIRECT X-LOCK STEM BOLTS, contact Lezyne for all replacement hardware.