

English User Manual

READ ENTIRE MANUAL BEFORE OPERATION to ensure proper use and care of your new Lezyne LED light. Traffic laws mandating lighting vary from country to country. Inform yourself about lighting laws and regulations in the country of use.

Our e-bike lights are powered by the motor of an e-bike and need to be manually installed. Proper installation may require some disassembly of the bike and motor (depending on make and model/battery type) and additional wiring to connect the light to the motor. Please contact the e-bike or motor manufacturer for installation instructions. Please note: Any disassembly may void the warranty of your e-bike. It is highly recommended to have a trained e-bike professional install your lights for you. Below is general information about electrical connectivity.

SUPER HIGH BEAM STVZO E1000

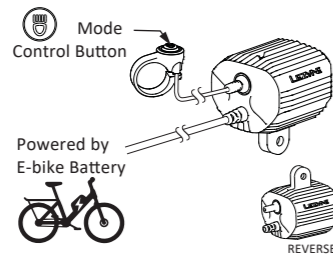
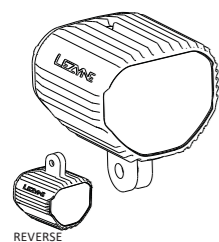

Technical Data

Output	1000 Lumen
Ampere LB/HB	0.65A / 1.3A
Wattage LB/HB	8W / 16W
Input voltage	10.5-13.5V AC DC (E-bike battery systems)
Illuminant LB/HB	3 LED / 6 LED
Power cable length	130 cm

	LOW BEAM	HIGH BEAM
	600 LUMEN	1000 LUMEN

Motor Compatibility

The SUPER HB STVZO E1000 is designed to work with a wide variety of E-Bike systems. It is intended as a solution to add a powerful headlight to an E-bike system. It supports power supplies and batteries from **10.5-13.5V**. It requires a minimum of **8W** to function properly and includes a Handle Bar Switch to power the light on/off and change modes. Please contact the bicycle manufacturer or supplier for information on compatibility and installation.

Warnings

To meet technical standards the light must be safely installed and ensured that the light position cannot be moved due to unintentional adjustment.

DO NOT LOOK DIRECTLY INTO LIGHT BEAM or shine into eyes of another.

Lezyne LED Lights have a water resistance rating of IPX7 under IEC standard 60529. Submerging the device is not recommended. If moisture does enter the casing, air out until completely dry.

DO NOT ATTEMPT TO REMOVE ELECTRONICS. Doing so will void warranty.

Lezyne USA, Inc. does not accept any liability for injuries or other damages resulting from the improper use or improper installation of this product in any circumstance.

Warranty

In U.S. and U.K., Lezyne LED Lights carry a two (2) year warranty from the original purchase date to the original owner (proof of purchase required). Lezyne warranties cover any manufacturing defects in materials or workmanship. Issues not covered by warranty include normal wear & tear, improper installation, attempting to access or modify electronics, damage or failure due to accident, misuse, abuse and/or neglect.

For all warranty issues worldwide, please contact the retailer that sold the product.

In the case of an LED not working properly or not working at all do not use your light anymore. These lights must be replaced immediately.

For any warranty questions contact: warranty@lezyne.com

Installation

Lezyne recommends that our E-Bike lights be installed by an E-bike professional. Below is general information about wiring and mounting the light to a compatible bike.

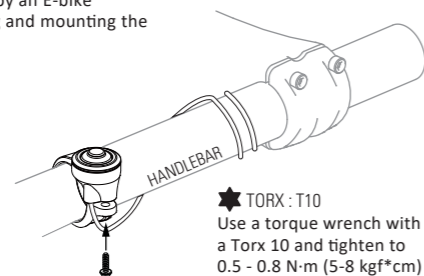
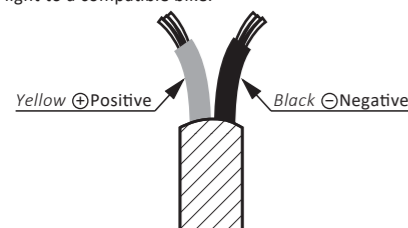

★ TORX: T10
Use a torque wrench with a Torx T10 and tighten to 0.5 - 0.8 N-m (5-8 kgf*cm)

Operation

The front light will be controlled via the on board electronics of the E-bike system for non-remote switch models. These lights are only to be mounted on E-Bikes with DC voltage that have their own battery charge indication and control. The e-bike system must be capable of automatically shutting the light off when the onboard battery reaches a critical voltage to avoid deep discharging of the battery.

Mounting

The light must be mounted at a height between 400 and 1200mm from the ground and cannot be blocked by any parts of the bike (tire, handlebar, etc.)

▼ Aluminum Fork Mount

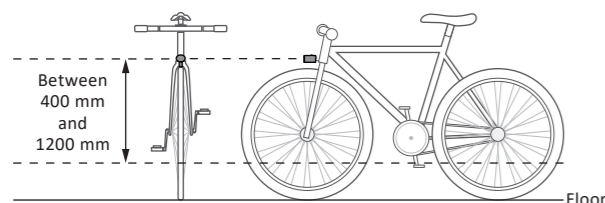

▼ Center Mount

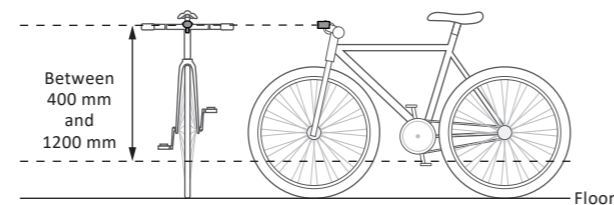

▼ Aluminum Fork Mount

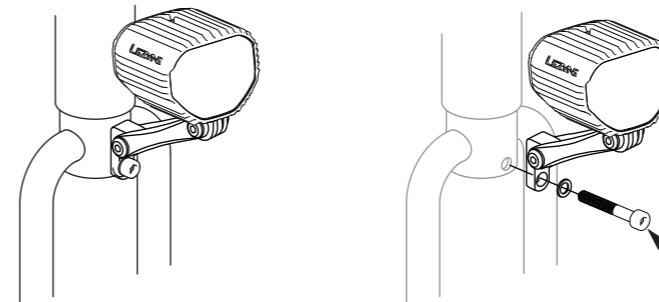

Bolt and Washer are not included because of the variety of mounting options.

▼ Center Mount

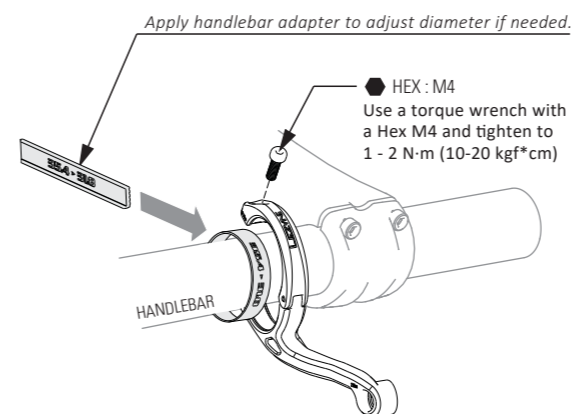

Apply handlebar adapter to adjust diameter if needed.

● HEX: M4
Use a torque wrench with a Hex M4 and tighten to 1 - 2 N-m (10-20 kgf*cm)

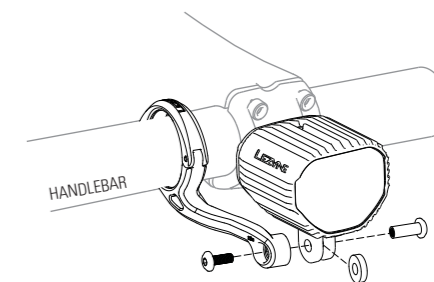

▼ How to Replace Center Mount with Aluminum Fork Mount

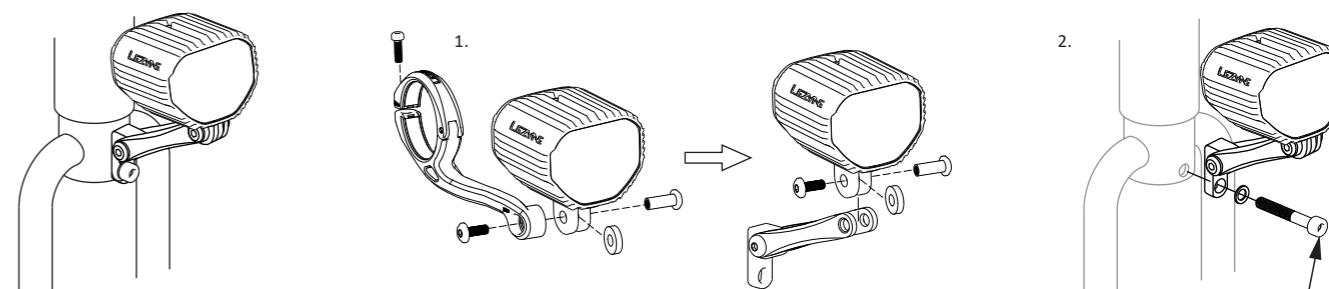

Bolt and Washer are not included because of the variety of mounting options.

More Information

For more information on Lezyne products, visit: www.lezyne.com