

➤ Instructions

Thule RideAlong Lite

100109, 100110, 100111

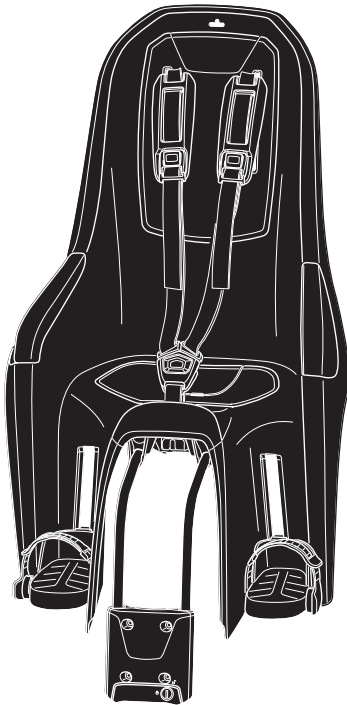

Carbon
fiber frame



0-9 M



9-72 M

9-22 kg

20-48,5 lbs

EN 14344



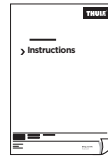
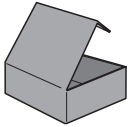

x1

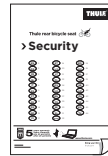

x1

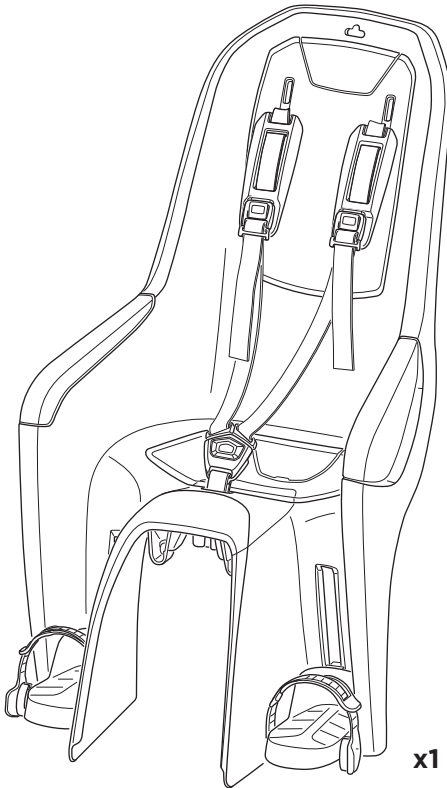

x1

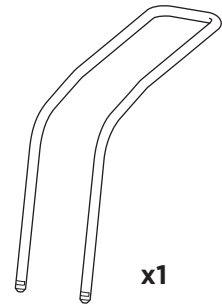

x1



x1



x1



x1



x4

M6x44
M6x1.7"



x4

M6x58
M6x2.3"

1

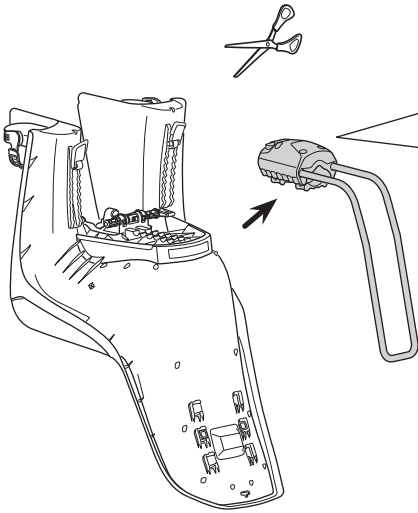

A

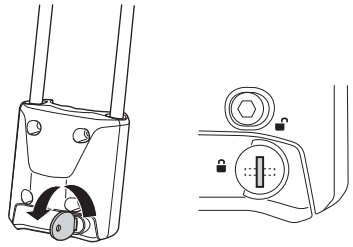

B

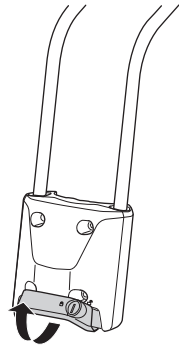

C

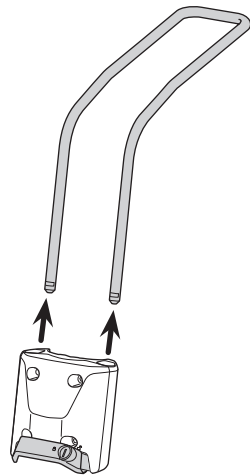

2

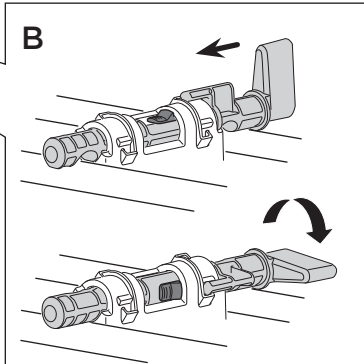
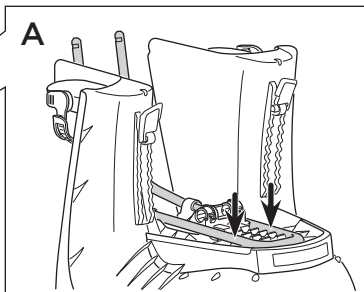
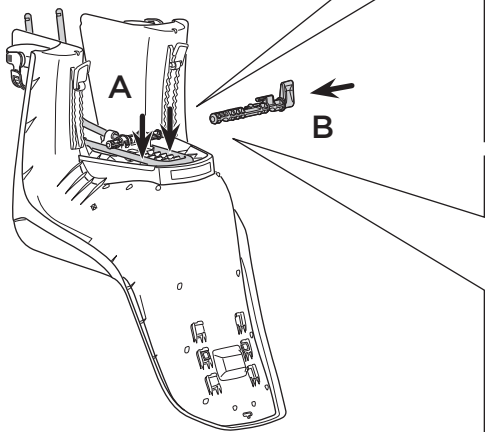
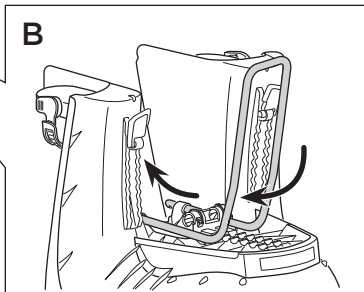
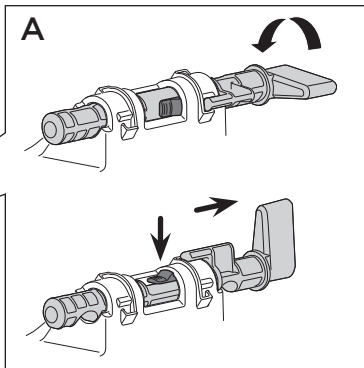
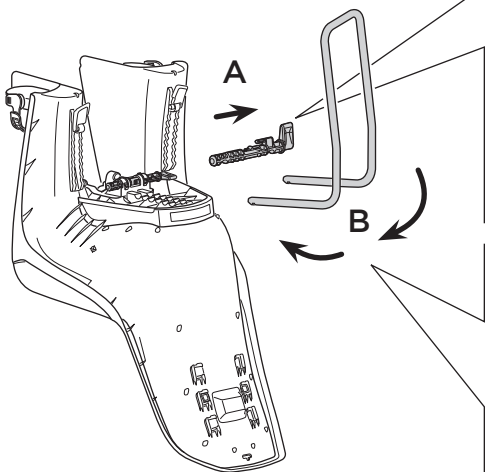

3



Ø 27.2-40 mm
Ø 1.07-1.57"

40x55 mm
1.57-2.16"

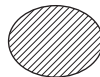
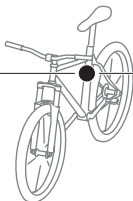

M6x44
M6x1.7"



M6x58
M6x2.3"

A

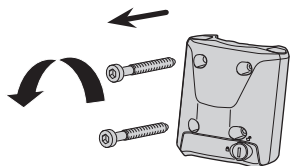

B

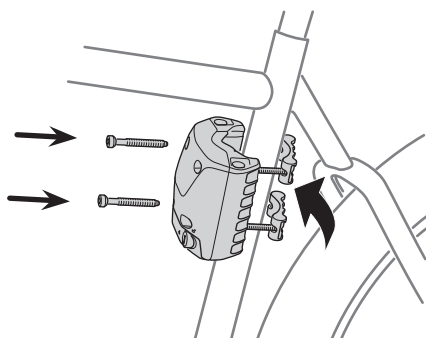

C

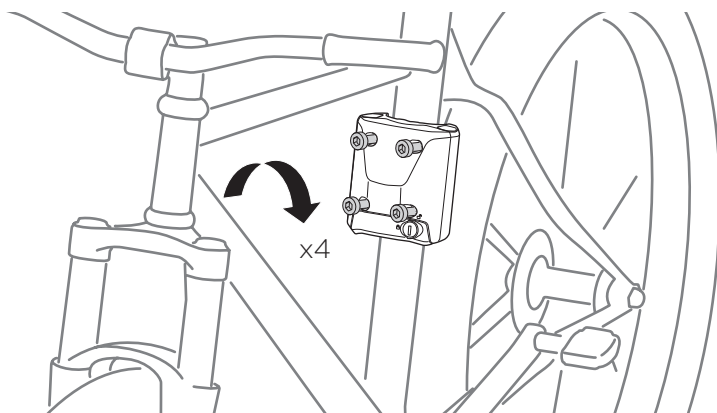

4

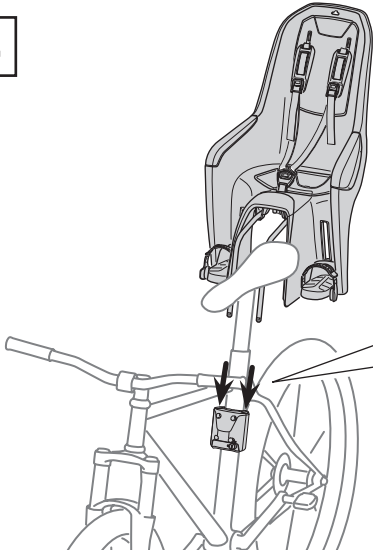

A

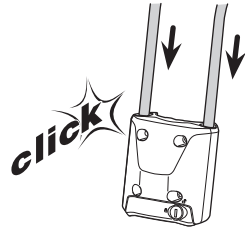

B

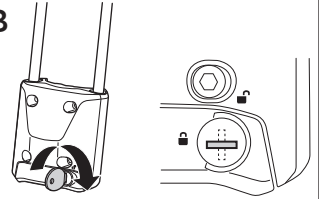

5

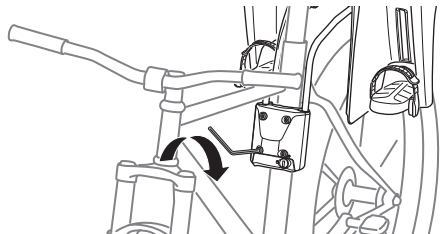
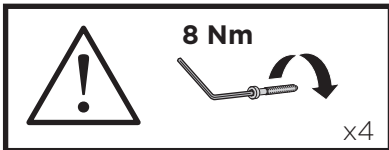
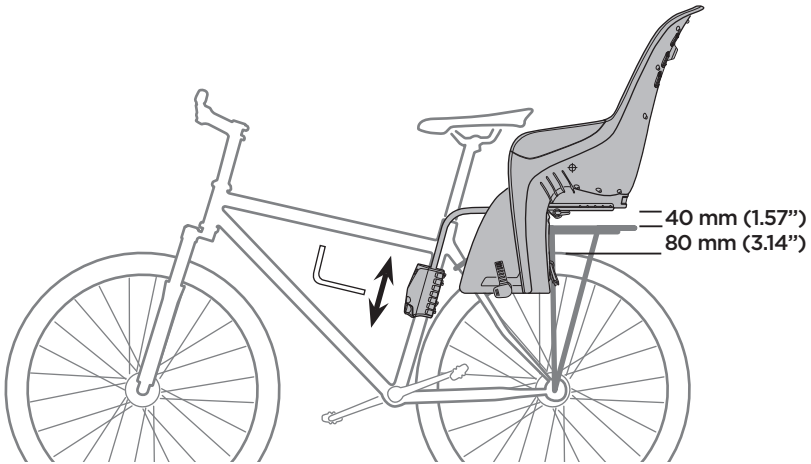

6

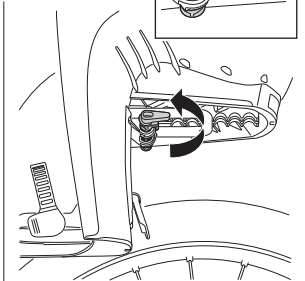
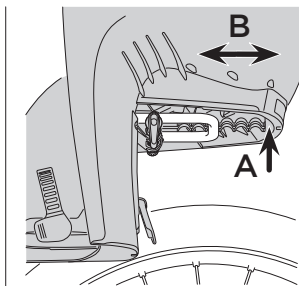
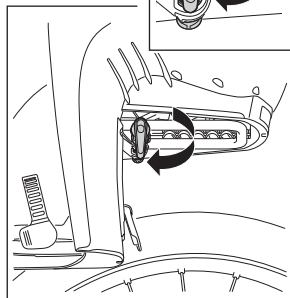
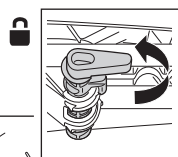
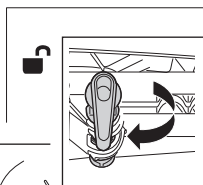
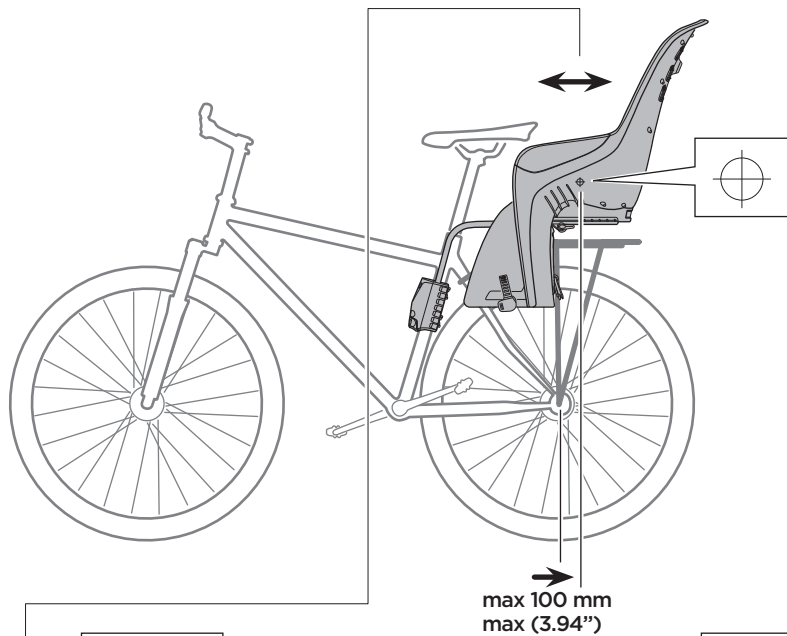
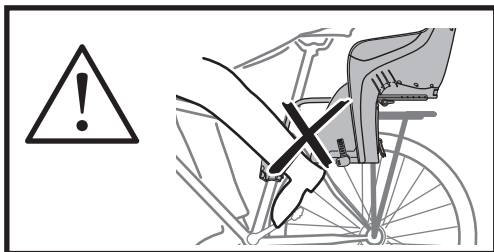

7

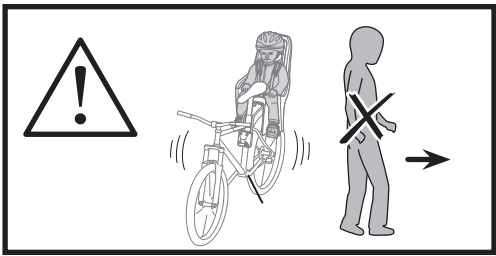
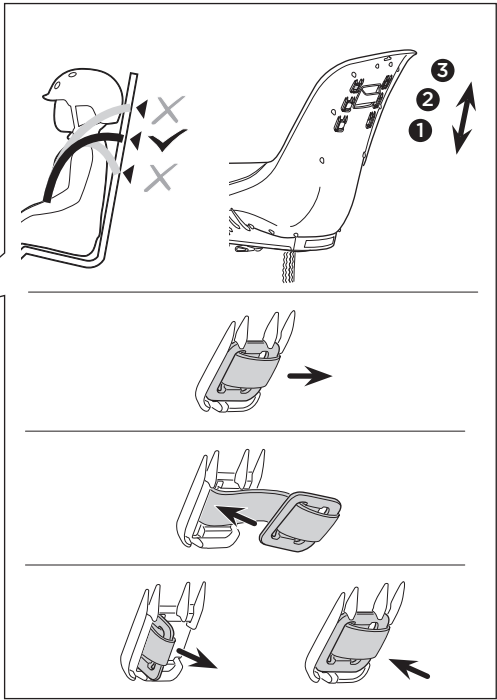
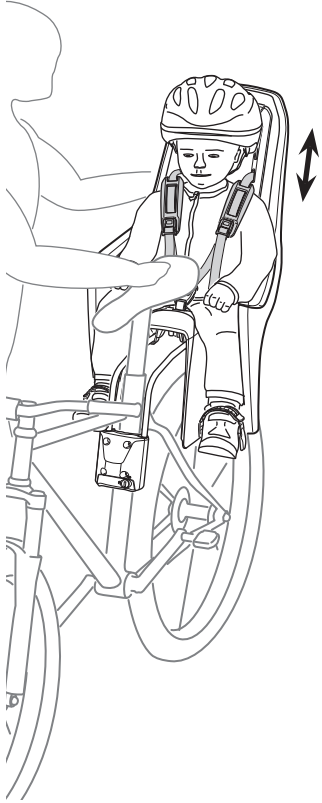
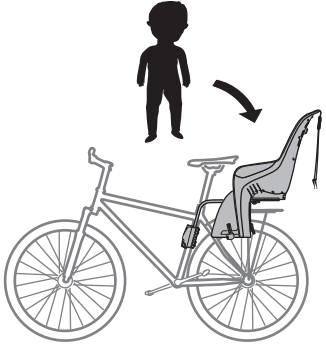
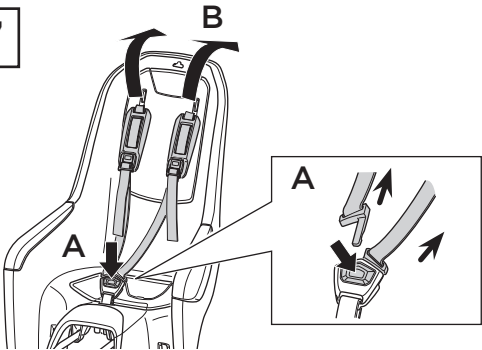

8

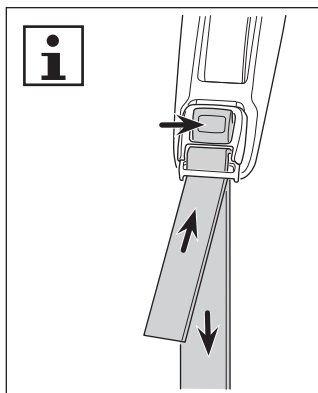
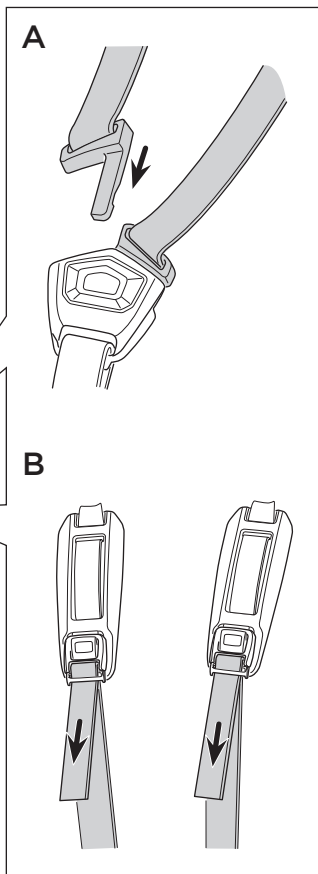
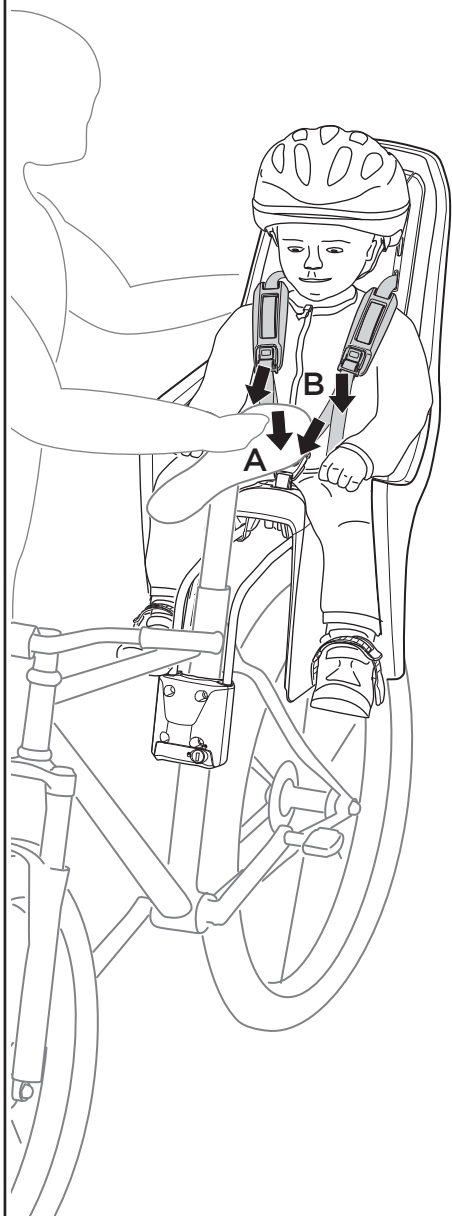

9

